

Dynamic Realization of Multiple Control Toffoli Gate

Abhoy Kole*, Arighna Deb†, Kamalika Datta*‡, and Rolf Drechsler*‡

*Cyber-Physical Systems, DFKI GmbH, Bremen, Germany

†School of Electronics Engineering, KIIT DU, Bhubaneswar, India

‡Institute of Computer Science, University of Bremen, Bremen, Germany

abhoy.kole@dfki.de, airghna.debfet@kiit.ac.in, {kdatta,drechsler}@uni-bremen.de

Abstract—*Dynamic Quantum Circuits (DQC)* is an inevitable solution for today’s *Noisy Intermediate Scale Quantum (NISQ)* systems. This enables realization of an n -qubit (where, $n > 2$) quantum circuit using only 2-qubits with the aid of additional non-unitary operations which is evident from the recent dynamic realizations of algorithms like *Quantum Phase Estimation (QPE)* and *Bernstein–Vazirani (BV)* as well as 3-qubit Toffoli operation. In this work, we introduce two different dynamic realization schemes for *Multiple Control Toffoli (MCT)* gates, for the first time to the best of our knowledge. We compare the respective realizations in terms of resources (e.g., gate, depth and nearest neighbor overhead) and computational accuracy. For this purpose, we apply the proposed dynamic MCT gates in *Deutsch–Jozsa (DJ)* algorithm, thereby realizing the traditional DJ algorithm as DQCs. Experimental evaluations show that one dynamic scheme for MCT gates leads to DQCs with better computational accuracy, while the other one results in DQCs with better computational resources.

Index Terms—Dynamic Quantum Circuit, Quantum Computing, Noisy Intermediate Scale Quantum (NISQ)

I. INTRODUCTION

In the *Noisy Intermediate Scale Quantum (NISQ)* era, the major challenge is how we can efficiently map quantum algorithms to these noisy computers [1]. The answer lies in analyzing whether quantum algorithms can be mapped to real hardware with less qubits. This was not possible until a new class of circuits known as *Dynamic Quantum Circuits (DQC)* was introduced. An important feature of DQC is that quantum algorithms comprising of n data qubits and m answer qubits can be realized using $m + 1$ qubits only. This enables algorithms to operate on fewer qubits: (i) making the fault tolerant computation more feasible using less number of qubits, and (ii) reducing the mapping overhead in terms of nearest neighbor cost on coupling restricted architecture.

Recently benefits of DQCs have been demonstrated for *Quantum Phase Estimation (QPE)* [2] algorithm. In another work two approaches for transforming Toffoli gate to its dynamic counterpart [3] is reported. As quantum algorithms may use *Multiple Control Toffoli (MCT)* gates, there is an urgent need to explore the dynamic realization of MCT gates. In this work, we explore the dynamic realization of MCT gate and propose two schemes based on: (i) the existing ancilla-free decomposition structure [4, Lemma 7.5], and (ii) the newly introduced decomposition solely suitable for the class of DQCs.

Most of the existing MCT decomposition methods are ancilla-based and cannot be applied for DQC transformation

due to the violation of the linear dependency among the qubits. Firstly, we use the ancilla-free decomposition as introduced in [4], and then propose another decomposition for DQC transformation. We finally compare both the resulting realizations of MCT gate in terms of resource constraints (gate, depth, and nearest neighbor overhead). We also evaluate the fidelity of the dynamic realization of MCT gate using *Deutsch–Jozsa (DJ)* [5] algorithm. Experimental evaluations show that the dynamic realization of MCT gate obtained from the newly proposed decomposition provides better computational accuracy over such obtained from existing decomposition, however, at the slight expense of additional gates.

The rest of the paper is organized as follows. Section II presents a brief background on quantum circuits, existing DQC methods and open problems. Section III introduces our proposed dynamic transformation approach for MCT gates, and in Section IV we discuss about the experimental results. Finally, Section V provides the concluding remarks.

II. BACKGROUND

A. Traditional Quantum Circuits (TQCs)

A traditional quantum circuit is a cascade of unitary operations performed on a specific set of qubits before being measured [6]. Typically, unitary gates operating on n qubits are represented by $2^n \times 2^n$ matrices. Typically a qubit can exist in basis states $|0\rangle$ or $|1\rangle$ or in superposition state, $|\psi\rangle = \alpha|0\rangle + \beta|1\rangle$, where α and β are complex coefficients and $|\alpha|^2 + |\beta|^2 = 1$. Measuring $|\psi\rangle$ results in basis state of $|0\rangle$ or $|1\rangle$ with probabilities $|\alpha|^2$ and $|\beta|^2$ respectively, which is a non-unitary operation.

Fig. 1 shows the realization of a 3-qubit circuit implementing Boolean function $\mathcal{F}(a, b) = a \rightarrow b$ using NOT (X), CNOT (CX) and CV/CV^\dagger gates where V/V^\dagger indicates square-root of NOT operation, i.e. $X = (V)^2 = (V^\dagger)^2$ and $VV^\dagger = I$. Here q_0^D and q_1^D are the control or data qubits and q_0^A is a target or an answer qubit.

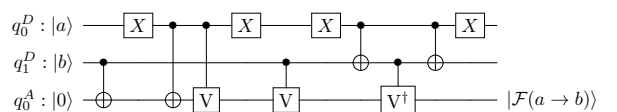

Fig. 1: An elementary gate realization of function $\mathcal{F}(a, b) = a \rightarrow b$.

B. Dynamic Quantum Circuits (DQCs)

Certain non-unitaries [2], i.e. mid-circuit measurements, active-reset and classically controlled gates can be executed on real hardware thereby enabling a new class of circuits known as *Dynamic Quantum Circuits (DQC)*. An important feature of DQC is that it requires at least two qubits to realize an n -qubit quantum circuit like QPE and BV. This is achieved by allowing a quantum circuit consisting of distinct set of *data* and *answer* qubits to be re-defined using a single data qubit and same number of answer qubit.

Fig. 2 shows the dynamic realization of the 3-qubit function $\mathcal{F}(a, b) = a \rightarrow b$ (see Fig. 1) using two qubits and two iterations between the data qubits ($|a\rangle$ and $|b\rangle$) and the answer qubit which is initialized with $|0\rangle$. An iteration involves all the required operations between a data qubit and the answer qubit(s).

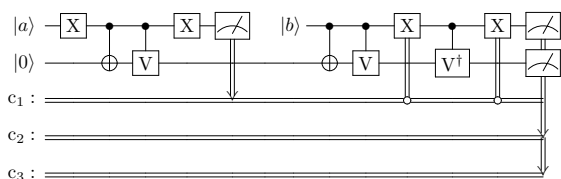

Fig. 2: Dynamic realization of 3-qubit function $\mathcal{F}(a, b) = a \rightarrow b$.

C. Open Problems

DQC has a great potential of realizing scalable quantum circuits using less qubits while preserving the desired functionality, e.g. BV and QPE algorithms [2]. However, the quantum realizations of these algorithms do not employ MCT gates. In contrast, there are several quantum circuits realizing important algorithms such as DJ [5], Grover's search [7] and Shor's factoring [8], that consist of multiple-control Toffoli gates.

Even though recently 2-control dynamic Toffoli is reported in [3], it still remains an open problem to obtain the dynamic realization of MCT gates. Transformation of such MCT operations into dynamic ones requires the following questions to be addressed:

- Can we apply the existing DQC transformation [3]?
- What would be the circuit complexity?
- What would be its computational accuracy?

All these questions are investigated in this work and the corresponding approaches and observations are outlined below.

III. PROPOSED DQC TRANSFORMATION

A. Dynamic MCT Operation

MCT operations comprising $(n + 1)$ qubits for $n \geq 3$ may need ancilla to obtain their corresponding less expensive Clifford+T descriptions [4; 6]. However, none of these clean [6, Quantum Circuits 4.3] and dirty [4, Lemma 7.2] ancilla based schemes are suitable for constructing dynamic MCT operation without compromising on computational accuracy. This is due to the presence of non-commutative operation sequences. The

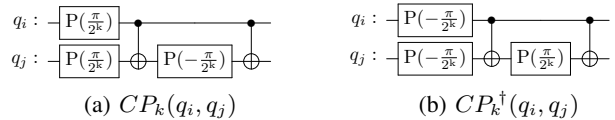

Fig. 3: CX and $P(\pm\frac{\pi}{2k})$ gate realization of CP_k/CP_k^\dagger operation.

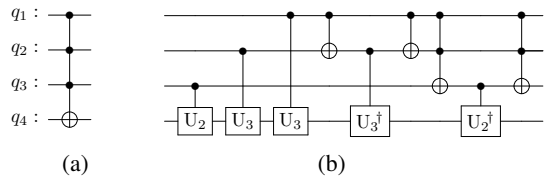

Fig. 4: Ancilla free realization: (a) A 4-qubit MCT gate. (b) An ancilla free decomposed MCT operation using controlled- X and $-U_3/U_3^\dagger$ gates [4, Lemma 7.5].

operation of a pair of Toffoli gates sharing a common qubit is not commute when the shared qubit acting as control of one gate becomes the target of another:

$$CCX(\{q_i, q_j\}; q_m) \cdot CCX(\{q_m, q_n\}; q_k) \neq CCX(\{q_m, q_n\}; q_k) \cdot CCX(\{q_i, q_j\}; q_m)$$

where $CCX(\{q_i, q_j\}; q_m)$ denotes a Toffoli gate with control qubits $\{q_i, q_j\}$ and target qubit q_m .

The qubit reordering problem is specifically addressed for Toffoli based network in [3] by using controlled unitaries of the form $C\sqrt{X}/C\sqrt{X}^\dagger$ for implementation. In a similar way, we can obtain an ancilla-free representation of a n -qubit MCT operation when controlled unitaries of the form CU_k where $U_k = \sqrt[2^k]{I}$, $k \in \mathbb{Z}^+$ are realizable [4, Lemma 7.5]. Considering $U_k = \sqrt[2^{k-1}]{Z}$, a CU_k/CU_k^\dagger operation can be realized as a CP_k/CP_k^\dagger operation using CX and single-qubit $\pm\frac{\pi}{2k}$ phase operation as shown in Fig. 3.

Assuming $U_k = \sqrt[2^{k-1}]{X}$, then CU_k/CU_k^\dagger operation is derived by introducing a pair of H operations (i.e., $X^r = HZ^rH$ for all $r \in \mathbb{R}$). Fig. 4 shows an intermediate level representation of a 4-qubit MCT operation using controlled- U_2 and $-U_3$ gates where $U_k = \sqrt[2^{k-1}]{X}$.

The ancilla free realization of MCT operation allows reordering of control qubits based on their interactions, which is an essential requirement for DQC transformation [3]. Fig. 5(a) shows one possible DQC transformation of a $(n + 1)$ -qubit MCT operation based on ancilla free decomposition in terms of controlled- $U_2, -U_3, \dots, -U_n$ gates where $U_k = \sqrt[2^{k-1}]{X}$. Considering the *unrolling* operation introduced in [3] the corresponding MCT realization requires one additional iteration as shown in Fig. 5(b).

B. An Alternate Dynamic MCT Structure

The ancilla free structure considered previously for the DQC transformation of a $(n + 1)$ -qubit MCT operation requires controlled unitaries CU_k/CU_k^\dagger , $k \in \mathbb{Z}^+$ in the range $2 \leq k \leq n$, where $U_k = \sqrt[2^k]{I}$. Instead of considering these 2^k -th root of identity operations, a similar ancilla free realization

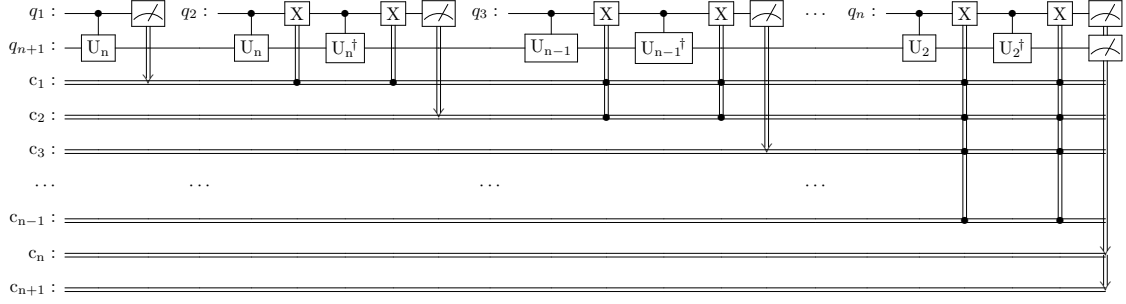

(a)

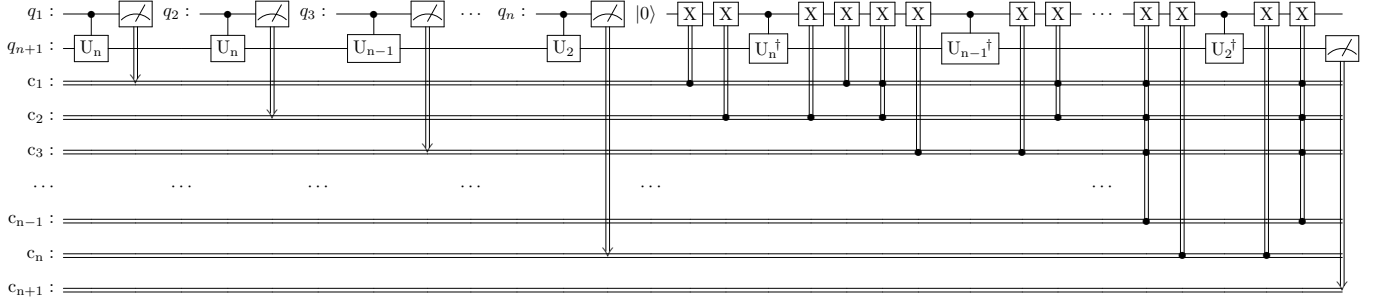

(b)

Fig. 5: (a) DQC transformation of a $(n + 1)$ -qubit MCT operation using controlled- $U_2, -U_3, \dots, -U_n$ operations, classically controlled- X operations and n iterations where $U_k = 2^{k-1}\sqrt{X}$. (b) Unrolling the conditional controlled- U_k^\dagger operations for $k = 2, \dots, n$ using one additional iteration defined in [3] the corresponding dynamic MCT operation.

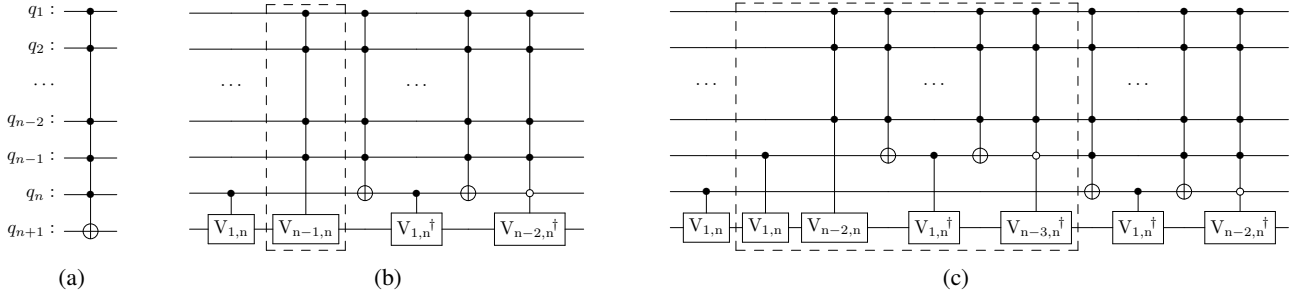

(a)

(b)

(c)

Fig. 6: Ancilla free decomposition of a MCT gate using CX and $CV_{k,n}$, $1 \leq k \leq n - 2$ operations where $V_{k,n} = \frac{n}{k}\sqrt{X}$. (a) A $(n + 1)$ -qubit MCT operation. (b) An ancilla free decomposition structure using CX and $CV_{k,n}$ operations. (c) The network after decomposing the multiple controlled $V_{n-1,n}$ operation surrounded by the dashed rectangle.

of the MCT operation of size $(n + 1)$ -qubit can be obtained employing controlled unitaries of the form $CV_{k,n}$, $k \in \mathbb{Z}^+$ for $1 \leq k \leq n - 2$ where $V_{k,n} = \frac{2n}{k}\sqrt{I}$. These assumed operations, $CV_{k,n}/CV_{k,n}^\dagger$ are also realizable using similar networks as shown in Fig. 3 by replacing the single-qubit $\pm \frac{\pi}{2k}$ phase gates with $\pm \frac{k\pi}{2n}$ accordingly. Fig. 6 shows the realization of a $(n + 1)$ -qubit MCT operation using CX and $CV_{k,n}$ gates.

During intermediate decomposition stages, there will be $(k + 2)$ -control $V_{k,n}^\dagger$, $1 \leq k \leq n - 2$ operations with one negative control (denoted by \circ , see Fig. 6). Since a negative control on a qubit q_i represents a classical complement operation (denoted by $\sim q_i$), $(k + 2)$ -control $V_{k,n}^\dagger$ can be realized without sacrificing the qubit ordering by implementing the operation $\sim q_i$ as $1 \oplus q_i$ on a clean ancilla. Fig. 7 shows the

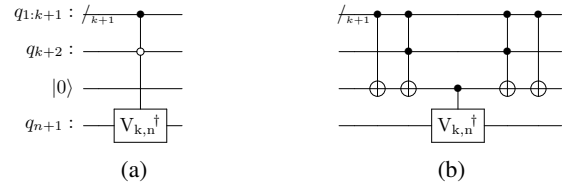

(a)

(b)

Fig. 7: Implementation of a $(k + 2)$ -control $V_{k,n}^\dagger$, $1 \leq k \leq n - 2$ operation where $(k + 2)$ th control is of negative polarity.

realization of a $(k + 2)$ -control $V_{k,n}^\dagger$ operation with $(k + 2)$ th control as negative using a clean ancilla. Thus, the construction of a $(n + 1)$ -qubit MCT operation using this approach requires exactly one clean ancilla for $n > 2$.

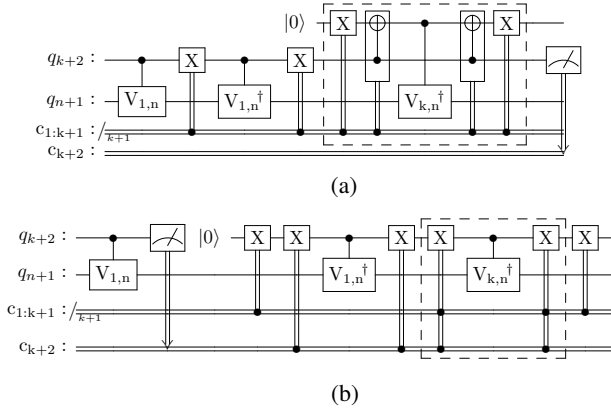

Fig. 8: DQC transformation of a $(n+1)$ -qubit MCT operation using controlled- $V_{k,n}$, $1 \leq k \leq n-2$ operations where $V_{k,n} = \frac{2^k}{k}\sqrt{X}$. (a) The $(k+2)$ th iteration using 3 qubits, i.e. an additional qubit as a clean ancilla to realize $(k+2)$ -control $V_{k,n}$ operation. (b) Unrolling the $(k+2)$ th iteration using 2 qubits and an additional iteration.

Having such realization of multiple control $V_{k,n}$, $1 \leq k \leq n-2$ operations with one negative control, the DQC transformation of a $(n+1)$ -qubit MCT gate represented by the network shown in Fig. 6 requires 3 qubits. Fig. 8(a) shows the corresponding dynamic realization of $(k+2)$ th iteration involving $(k+2)$ th, $1 \leq k \leq n-2$ control qubit and the target qubit besides classically controlled unitary operations and a clean ancilla. The first two iterations of the proposed $V_{k,n} = \frac{2^k}{k}\sqrt{I}$ based dynamic MCT description will be similar to the DQC transformation based on $U_k = \frac{2^k}{k}\sqrt{I}$ (see Fig. 5(a)) where operations U_k/U_k^\dagger are replaced with $V_{1,n}/V_{1,n}^\dagger$.

Similarly, an unrolling [3] leads to a corresponding 2-qubit realization. Fig. 8(b) shows the $(k+2)$ th iteration unrolled into two iterations. The initial n iterations for $V_{k,n} = \frac{2^k}{k}\sqrt{I}$ based dynamic MCT transformation can be obtained from the $U_k = \frac{2^k}{k}\sqrt{I}$ based dynamic realization (see Fig. 5(b)) by replacing the operation U_k with $V_{1,n}$. Since the unrolling splits a iteration into two iterations, the final $(n+1)$ iteration can be obtained by merging all the second iterations obtained from the unrolling.

IV. EXPERIMENTAL EVALUATION

For assessing the effectiveness of the proposed dynamic MCT realizations, we have conducted the experiments in two phases: (i) evaluating the resource overhead in terms of gate overhead (unitary and non-unitary operations), circuit depth and required qubits, and (ii) validating the execution outcome. All the quantum circuits are described using unitaries: $\{CX, P$ (Phase), $H, X\}$ together with non-unitaries: $\{\text{mid-circuit measurement, active reset, classically controlled gate}\}$. All non-unitaries are treated as single qubit operations (denoted as U) except classically controlled gate of the form

$$\text{if}(\text{creg} == \text{value}) \text{CX } \text{qreg}[i], \text{qreg}[j];$$

which is treated as a two-qubit CX operation for consistency. Initially, we generate four set of dynamic MCT netlists: (i) **DQC_L7.5** and (ii) **DQC_L7.5_U** represent the dynamic

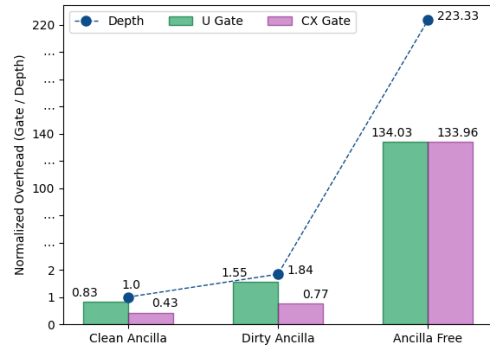

Fig. 9: Resource overhead in realizing MCT gates of size 3 to 16 qubits using clean ancilla [6, Quantum Circuits 4.3], dirty ancilla [4, Lemma 7.2] and no ancilla [4, Lemma 7.5]. The average resources are normalized by the depth average of clean ancilla implementations.

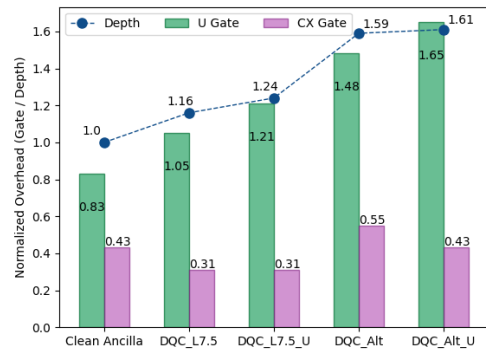

Fig. 10: Resource overhead in realizing MCT gates up to 16 qubits using clean ancilla and proposed dynamic approaches **DQC_L7.5**, **DQC_L7.5_U**, **DQC_Alt** and **DQC_Alt_U**. The depicted average resources are normalized by the depth of clean ancilla implementations.

netlists based on [4, Lemma 7.5] and its corresponding unrolled version, respectively whereas (iii) **DQC_Alt** and (iv) **DQC_Alt_U** denote the dynamic netlists due to the proposed decomposition and its unrolled version, respectively. In order to obtain the uniform *basis gate* description of the netlists considered for experiments, we have used the *transpile* API from *Qiskit SDK* [9].

A. Evaluating Gate Overhead

In order to make an effective comparison, we have analysed the resource overheads in realizing the traditional MCT operations up to 16 qubits using clean ancilla [6, Quantum Circuits 4.3], dirty ancilla [4, Lemma 7.2] and no ancilla [4, Lemma 7.5]. The compendium is presented in the form of Fig. 9. While ancilla free method is able to minimize qubits, but the gates and depth is increased over 100 times.

Since clean ancilla [6, Quantum Circuits 4.3] based realization is less expensive in terms of gates and depths, we have used this to compare with the corresponding dynamic

TABLE I: Results of dynamic realization of MCT operation based on [4, Lemma 7.5] and alternate decomposition structures compared with the corresponding clean ancilla [6, Quantum Circuits 4.3] based traditional realization.

n	Clean Ancilla [6]				[4, Lemma 7.5] Based DQC Transformation						Alternate DQC Transformation									
	m	U	CX	D	m = 2			m = 2, Unrolled			Avg. Improv.(%)		m = 2 if n = 3; m = 3 otherwise.			m = 2, Unrolled			Avg. Improv.(%)	
					U	CX	D	U	CX	D	δ_G	δ_D	U	CX	D	U	CX	D	δ_G	δ_D
3	3	9	6	11	19	6	24	23	6	26	-80.00	-127.27	19	6	24	23	6	26	-80.00	-127.27
4	5	21	12	28	33	10	39	39	10	42	-39.39	-44.65	40	14	46	46	12	48	-69.70	-67.86
5	7	33	18	42	47	14	54	55	14	58	-27.45	-33.34	61	22	68	69	18	70	-66.67	-64.29
6	9	45	24	56	61	18	69	71	18	74	-21.74	-27.68	82	30	90	92	24	92	-65.22	-62.50
7	11	57	30	70	75	22	84	87	22	90	-18.39	-24.29	103	38	112	115	30	114	-64.37	-61.43
8	13	69	36	84	89	26	99	103	26	106	-16.19	-22.03	124	46	134	138	36	136	-63.81	-60.71
9	15	81	42	98	103	30	114	119	30	122	-14.64	-20.41	145	54	156	161	42	158	-63.42	-60.20
10	17	93	48	112	117	34	129	135	34	138	-13.48	-19.20	166	62	178	184	48	180	-63.12	-59.82
11	19	105	54	126	131	38	144	151	38	154	-12.58	-18.26	187	70	200	207	54	202	-62.90	-59.53
12	21	117	60	140	145	42	159	167	42	170	-11.87	-17.50	208	78	222	230	60	224	-62.71	-59.29
13	23	129	66	154	159	46	174	183	46	186	-11.29	-16.89	229	86	244	253	66	246	-62.57	-59.09
14	25	141	72	168	173	50	189	199	50	202	-10.80	-16.37	250	94	266	276	72	268	-62.44	-58.93
15	27	153	78	182	187	54	204	215	54	218	-10.39	-15.94	271	102	288	299	78	290	-62.34	-58.79
16	29	165	84	196	201	58	219	231	58	234	-10.04	-15.56	292	110	310	322	84	312	-62.25	-58.67

$n \rightarrow$ MCT gate size; $m \rightarrow$ Number of qubits; $U \rightarrow$ Number of 1-qubit gates; $CX \rightarrow$ Number of 2-qubit gates; $D \rightarrow$ Circuit depth; $\delta_G / \delta_D \rightarrow$ Average ($(m = c_1), (m = c_2, \text{Unrolled})$) increase in $(U + CX) / D$ over traditional clean ancilla based realization.

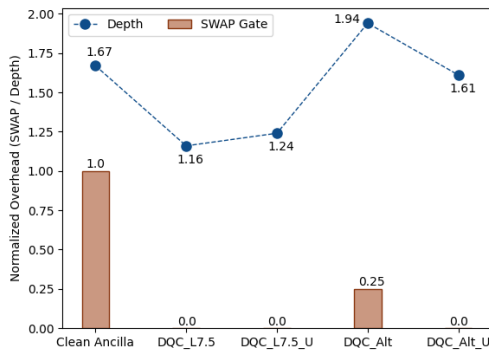

Fig. 11: SWAPs and depth analysis in mapping clean ancilla and dynamic (DQC_L7.5, DQC_L7.5_U, DQC_Alt and DQC_Alt_U) MCT realizations of size up to 16 qubits on IBM *Prague* QPU using [10]. The average SWAPs are normalized by the SWAP average of clean ancilla based scheme. The depths are normalized by the depth average of the un-mapped clean ancilla implementations.

realization. Fig. 10 shows an outline of the comparisons. A detailed comparison is presented in the form of Table I.

It can be observed that while the corresponding dynamic realizations show an increase in single qubit operations and depth (almost two times for DQC_Alt_U), the CX operations that are more noisy, vary marginally. Finally, minimization of qubit in dynamic realization further reduces the nearest neighbor overhead (i.e., SWAPs) for compliance with coupling restricted architecture. Fig. 11 shows the average SWAPs and depth increase in mapping these clean ancilla based [6, Quantum Circuits 4.3] traditional and proposed dynamic realization of MCT gates of size up to 16 qubits on the 33-qubit IBM *Prague* QPU using a state of the art approach [10]. It may be noted that due to the involvement of 3 qubits, DQC_Alt requires additional SWAPs for mapping, which is much less

than mapping the clean ancilla based design.

It can be observed (see Fig. 10, 11 and Table I) that compared to the traditional most economical clean ancilla based realization, the DQC_L7.5 (or DQC_L7.5_U) seems more beneficial as the realization (i) involves only 2 qubits, (ii) does not have mapping overhead, and (iii) needs less CX operations.

B. Evaluating Operational Fidelity

In order to evaluate the performance of realized dynamic MCT gate with respect to the traditional one we have used (i) *Deutsch-Jozsa* (DJ) [5] algorithm, (ii) *Qiskit Aer* [9] simulator and (iii) device noise of 7-qubit cloud deployed freely accessible IBM *Jakarta* QPU.

To verify the operational accuracy of the dynamic realizations, we use the MCT operation as the *oracle* in DJ algorithm to determine the constant (balance) nature of the operations. The *Qiskit Aer* [9] simulator is used as the ideal execution platform to evaluate the computational accuracy of the proposed dynamic realizations. Fig. 12(a) shows the corresponding execution outcomes of both the traditional and dynamic DJ algorithms considering clean ancilla based traditional [6, Quantum Circuits 4.3] and [4, Lemma 7.5] based dynamic (i.e., DQC_L7.5 and DQC_L7.5_U) MCT realizations as the respective oracle.

Similarly, Fig. 12(b) shows the evaluation curve of DJ algorithm for dynamic MCT oracles DQC_Alt and DQC_Alt_U. The error curves $|T-DJ - D-DJ|$ and $|T-DJ - D-DJ-U|$ (see Fig. 12(a) and 12(b)) indicate that for smaller MCT gates of size 3 or 4 qubits, the unrolled dynamic MCT DQC_L7.5_U and DQC_Alt_U provide better accuracy, while the dynamic MCT DQC_L7.5 and DQC_Alt give better accuracy for MCT gates of size 5 or more qubits. Further, these error curves of DQC_Alt and DQC_Alt_U reflect the impression of better computational accuracy than dynamic MCT DQC_L7.5 and DQC_L7.5_U.

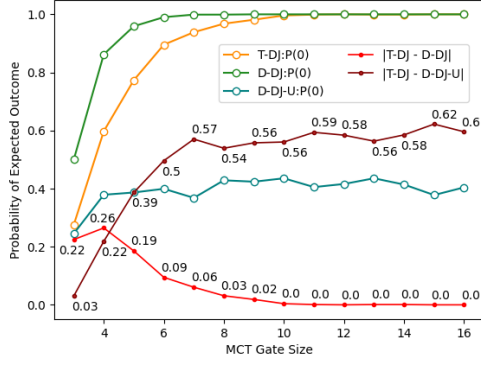

(a) [4, Lemma 7.5] based DQC transformation

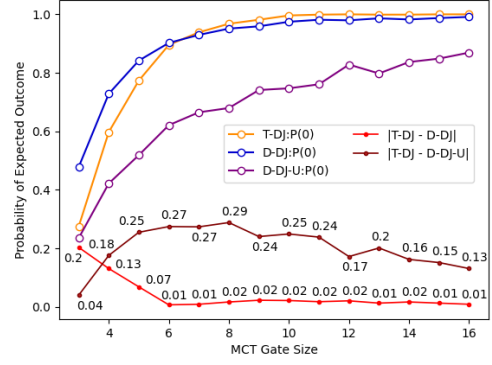

(b) Alternate DQC transformation

Fig. 12: Accuracy in evaluating MCT gates as oracles in DJ algorithm. (a) The constant and error curves of evaluating traditional clean ancilla based, and dynamic (DQC_L7.5 and DQC_L7.5_U) realization of MCT gate as oracle in DJ algorithm. (b) The constant and error curves of evaluating traditional clean ancilla based, and dynamic (DQC_Alt and DQC_Alt_U) realization of MCT gate as oracle in DJ algorithm.

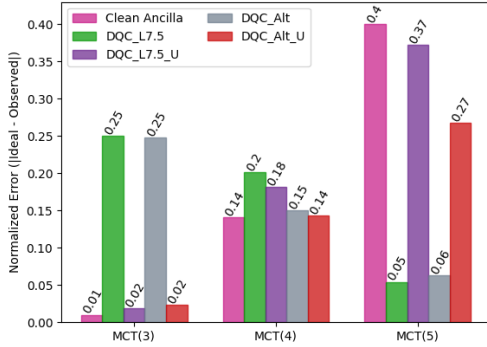

Fig. 13: Noise in determining constant (balance) nature of MCT gates considered as oracle in DJ algorithm. The oracle MCT gates are realized as one traditional (using clean ancilla) and four dynamic (using DQC_L7.5, DQC_L7.5_U, DQC_Alt and DQC_Alt_U) circuit.

Finally, a noise analysis is presented in Fig. 13 considering the 7-qubit IBM *Jakarta* device noise in *Qiskit Aer* [9]. The number of device qubits restrict the analysis for MCT gates of size up to 5 qubits (requires two clean ancilla for traditional realization). The error is computed as the difference between the ideal and the noisy outcome of executing all the five set of realizations. It can be observed that DQC_Alt and DQC_Alt_U provides better fidelity than DQC_L7.5 and DQC_L7.5_U.

V. CONCLUSION

DQC enables realization of quantum circuits using fewer qubits only due to the availability of non-unitaries like active reset, mid-circuit measurement and classically controlled gates. In this paper we propose two dynamic realizations of MCT gates for the first time to the best of our knowledge. We precisely (i) introduce a dynamic transformation scheme employing the existing ancilla-free decomposition, (ii) propose a new decomposition suitable for dynamic transformation, (iii)

evaluate both proposed approaches in terms of resources (e.g., gate, depth, and nearest neighbor overhead) and fidelity on DJ algorithm. We perform extensive experiments to analyze gate overhead and operational fidelity. We further show the SWAP gate requirements for our proposed method on an IBM machine. This work can lead to revisiting and analyzing execution of quantum circuits for better reliability.

REFERENCES

- [1] B. Cheng *et al.*, “Noisy intermediate-scale quantum computers,” *Front. Phys.*, vol. 18, no. 2, p. 21308, Mar 2023.
- [2] A. Córcoles *et al.*, “Exploiting dynamic quantum circuits in a quantum algorithm with superconducting qubits,” *Phys. Rev. Lett.*, vol. 127, no. 10, 2021.
- [3] A. Kole, A. Deb, K. Datta, and R. Drechsler, “Extending the design space of dynamic quantum circuits for Toffoli based network,” in *Des. Autom. Test Eur.*, 2023, pp. 1–6.
- [4] A. Barenco *et al.*, “Elementary gates for quantum computation,” *Phys. Rev. A*, vol. 52, no. 5, pp. 3457–3467, Nov 1995.
- [5] D. Deutsch and R. Jozsa, “Rapid solution of problems by quantum computation,” in *Proc. R. Soc. Lond. A*, vol. 439, 1992, pp. 553–558.
- [6] M. Nielsen and I. Chuang, *Quantum Computation and Quantum Information*. Cambridge Univ. Press, Oct 2000.
- [7] L. Grover, “A fast quantum mechanical algorithm for database search,” in *ACM Symp. on Theory of computing*, Jul 1996, pp. 212–219.
- [8] P. W. Shor, “Algorithms for quantum computation: Discrete logarithms and factoring,” in *Symp. on Foundations of Computer Science*, Nov 1994, pp. 124–134.
- [9] Qiskit Contributors, “Qiskit: An open-source framework for quantum computing,” 2023.
- [10] A. Kole, S. Hillmich, K. Datta, R. Wille, and I. Sengupta, “Improved mapping of quantum circuits to IBM QX architectures,” *IEEE Trans. Comput.-Aided Des. Integr. Syst.*, vol. 39, no. 10, pp. 2375–2383, 2020.